

Article number: 03554070

Description: Fluro hydraulic rod end FMA 70D

Measures

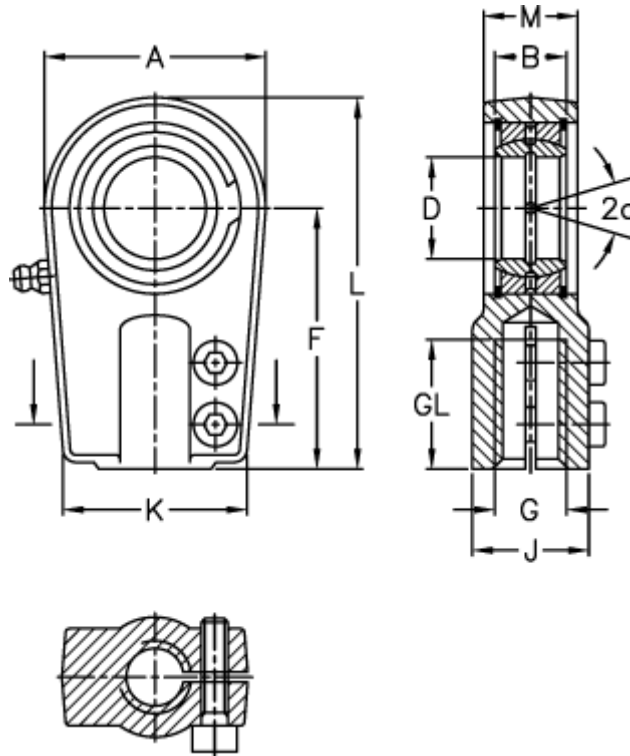

A	= 144	J	= 105
a (degrees)	= 6	K	= 130
B	= 49	L	= 278
D	= 70	M	= 55
Dynamic load C (kN)	= 440	Static load C0 (kN)	= 721
F	= 195	Torque (N m)	= 160
g	= M80x3	Weight	= 9500
GL	= 110		